

TOMCAT

Handmade in U.S.A. - 1986

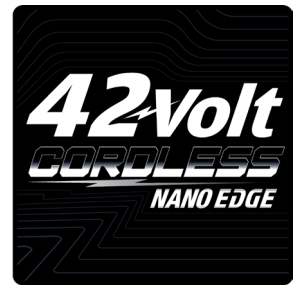

Operating Instructions (EN) & Parts Manual

MODELS:

42 Volt Nano Edge Cordless



Read these Instructions before using the machine.



Read these Safety Messages before using the machine.

BLANK
THIS PAGE WAS INTENTIONALLY LEFT BLANK

TABLE OF CONTENTS

Table of Contents	3
Safety	4
Maintenance	6
Transportation	7
Operation	8
Handle Attachment	11
Common Wear Parts	12
NANO EDGE Pads:.....	12
SPARE PARTS & KITS:.....	12
Parts	13

You will see four kinds of safety reminders in this manual:

<p>! WARNING</p> <p>WARNING indicates a potentially hazardous situation which, if not avoided, could result in death or serious injury.</p>
<p>! CAUTION</p> <p>CAUTION indicates a potentially hazardous situation which, if not avoided, could result in minor or moderate injury or damage to this machine or nearby objects. CAUTION also can be used to alert against unsafe practices.</p>
<p>NOTICE</p> <p>NOTICE indicates information considered important, but not hazard-related. This safety message may be related to property damage or warranty warnings.</p>

Your safety, and that of others, is very important. Operating this machine safely is an important responsibility.

DO NOT OPERATE THIS MACHINE:

- Unless you are trained and authorized to do so by an RPS authorized and certified distributor
- Unless you have read and understood this complete Operator's Manual
- On surfaces with greater than a 2% / 3.49° grade at any time
- In water depth more than 0.125" (3.175mm)
- On carpeting - Only for use on flat, smooth, hard floor surfaces

WHEN OPERATING THIS MACHINE:

- Remove loose objects from the floor that could be projected from the oscillating pad
- Keep your hands and feet away from the oscillating pad
- Do not operate this machine where flammable liquids are present
- Use caution when maneuvering close to walls
- Use PPE (Personal Protective Equipment)

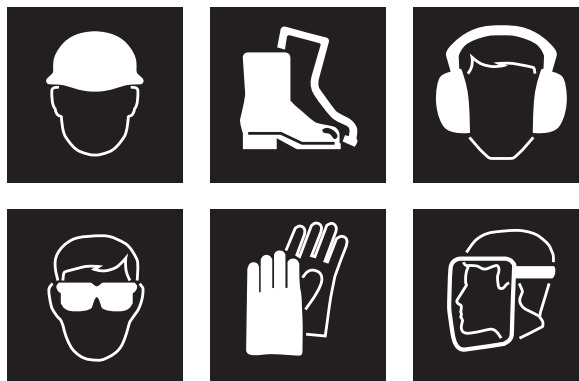

BEFORE LEAVING THE MACHINE:

- Turn the machine *OFF* and unplug the power cord from wall AC power

! WARNING

Do not operate this machine around any flammable materials. Work areas should be well ventilated.

! WARNING

Always wear safety goggles when operating this machine to avoid eye injury from debris projected from the oscillating pad.

! WARNING

To avoid electrical shock, do not use this machine if the handle has gotten wet or if water has penetrated past the plastic shell.

! WARNING

To avoid electrical shock, unplug the power cord before adjusting the handlebar height or replacing the pad.

! WARNING

Always turn off this machine and unplug the power cord before leaving it unattended. Do not allow untrained persons to operate this machine.

! WARNING

Always wear a dust mask when operating this machine to avoid inhaling dust created by the oscillating pad. Inhaling dust created by this machine can cause serious respiratory injury.

! WARNING

To avoid electrical shock, do not pull on the power cord to move the machine or unplug the power cord from the electrical outlet.

! CAUTION

To avoid personal injury and/or damage to this machine, the persons lifting the machine should carry the machine by the base. Do not attempt to lift the machine by the handlebar only.

! CAUTION

Always unplug the power cord before attempting to transport this machine.

! CAUTION

Always leave the pad on the machine when transporting to avoid damage to the grip face.

! WARNING

Do not remove, paint over or destroy warning decals. If warning decals become damaged, call 1-262-681-3583 for free replacements.

! WARNING

To avoid electrical shock, do not operate this machine over electrical floor outlets.

! WARNING

Dress safely. Keep hands, feet and loose clothing away from moving parts on this machine.

! WARNING

To avoid electrical shock, always keep the power cord clear of the oscillating pad and in good condition. Always lift the power cord over the machine.

! WARNING

Never operate this machine under the influence of alcohol or drugs. Do not allow anyone under the age of 18 to operate this machine.

! WARNING

Never sand wood decks. Due to uneven surfaces this could lead to damage to the machine as well as some pressure treated wood found in decking contains arsenic, which, when sanded, will create hazardous dust.

! CAUTION

Do not operate this machine if any parts have been damaged or removed.

! CAUTION

Alterations to this machine may result in personal injury or property damage, and voids the warranty.

! CAUTION

Always unplug the power cord before changing the pad.

MAINTENANCE

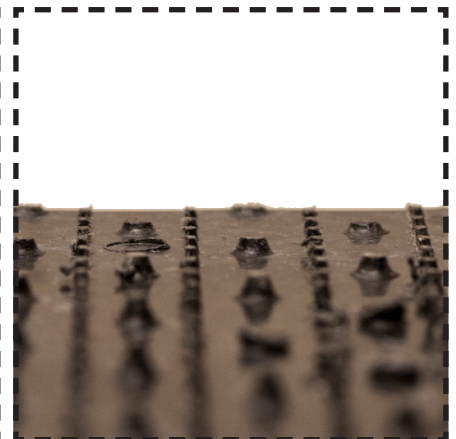
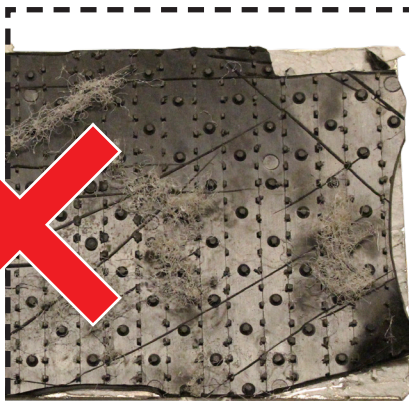
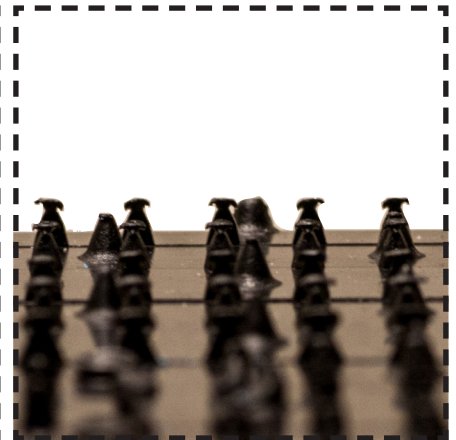
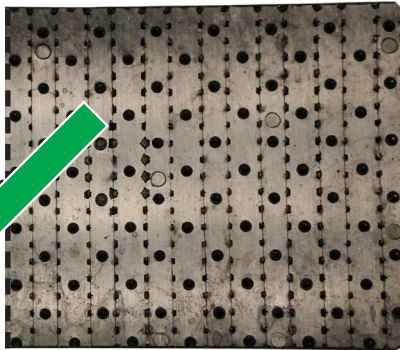
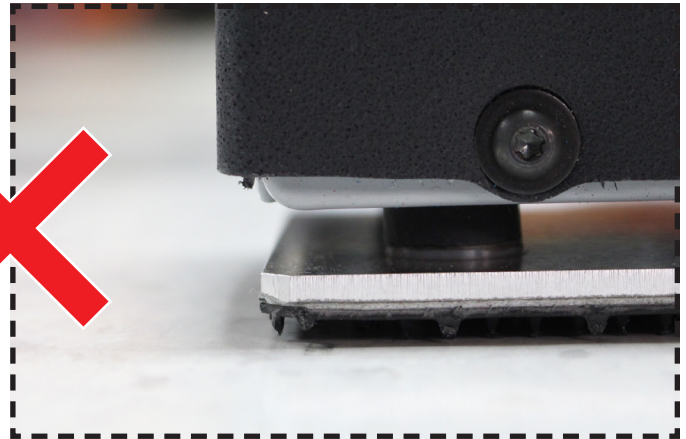
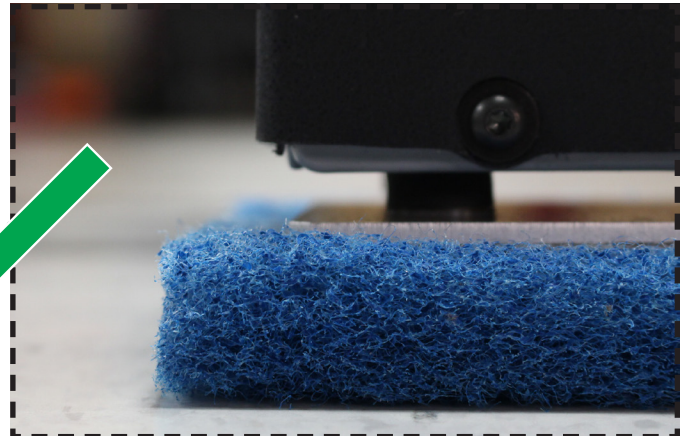

TRANSPORTATION

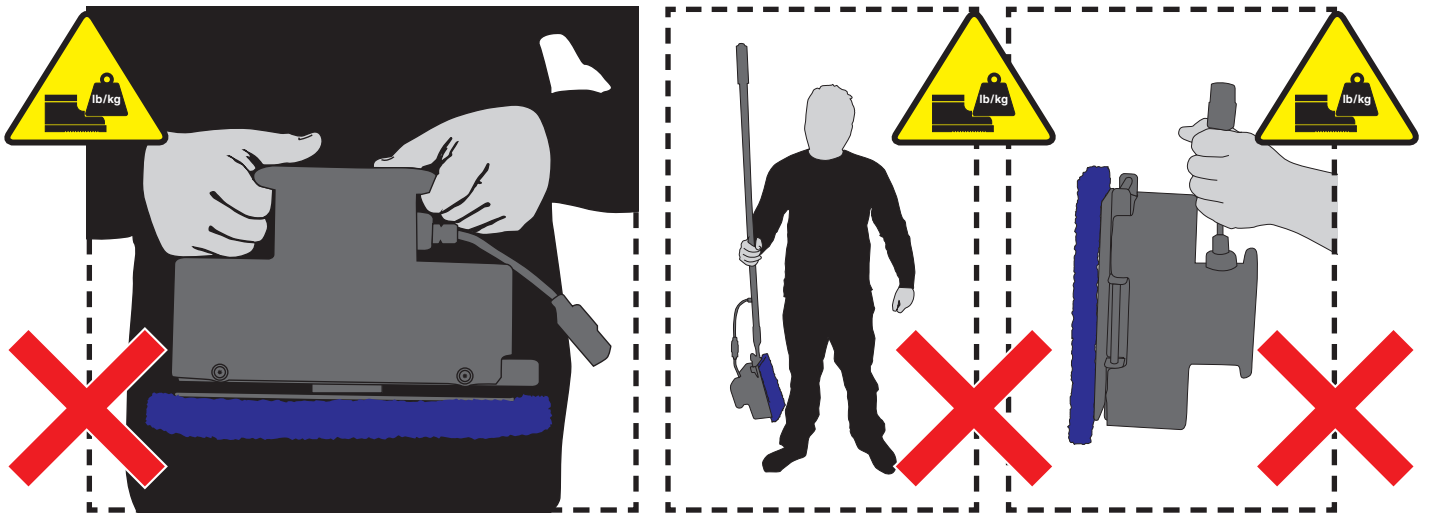
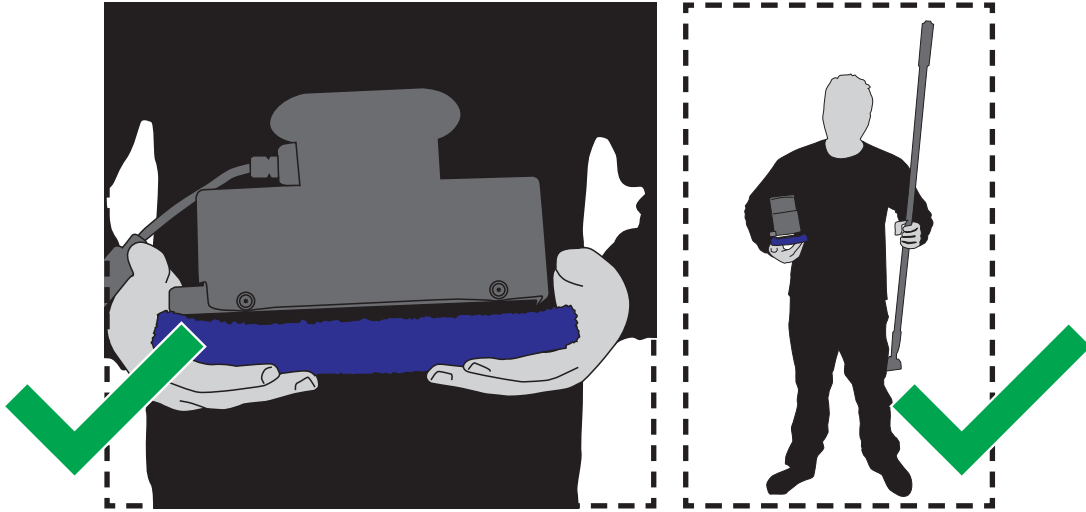

OPERATION

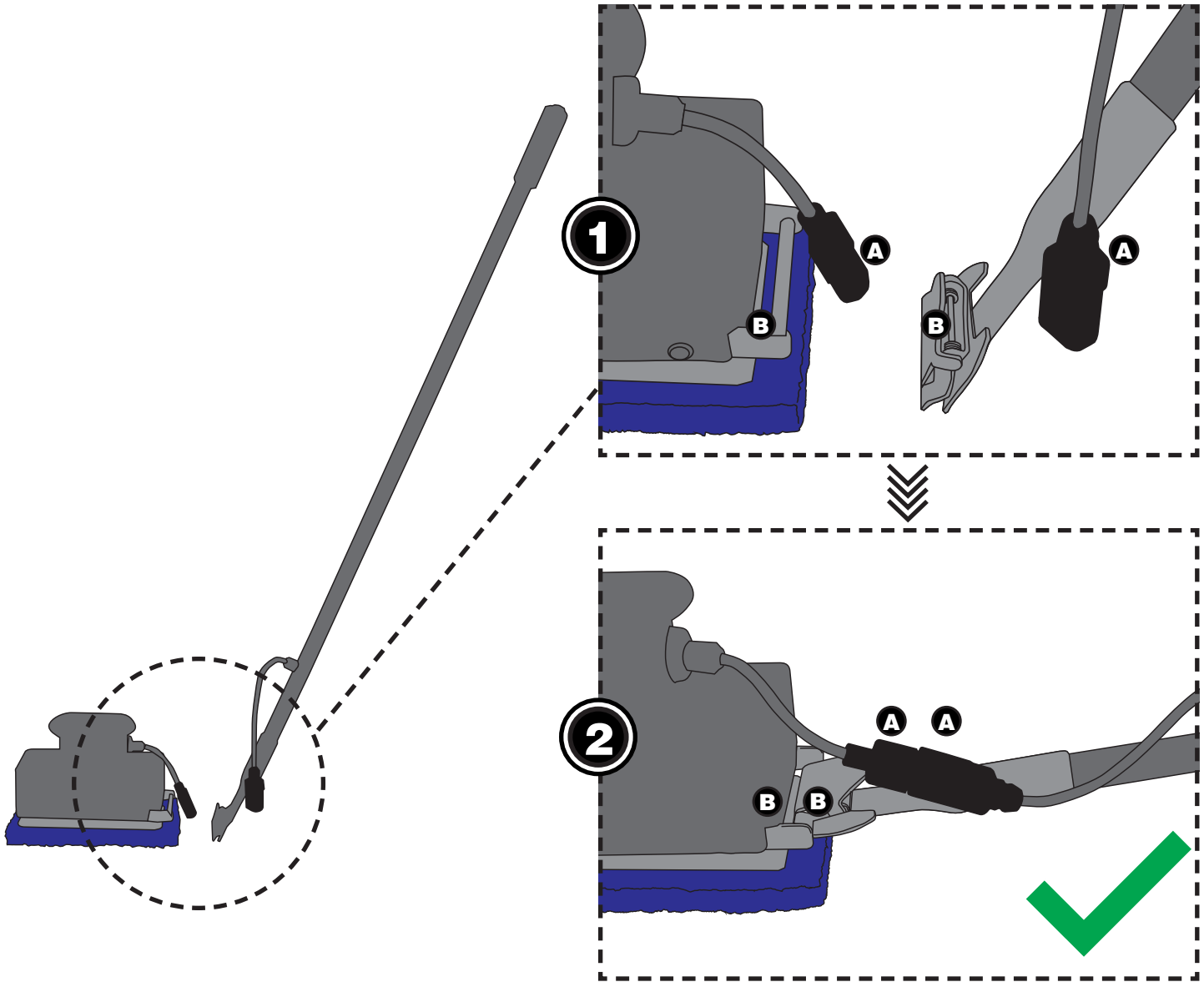

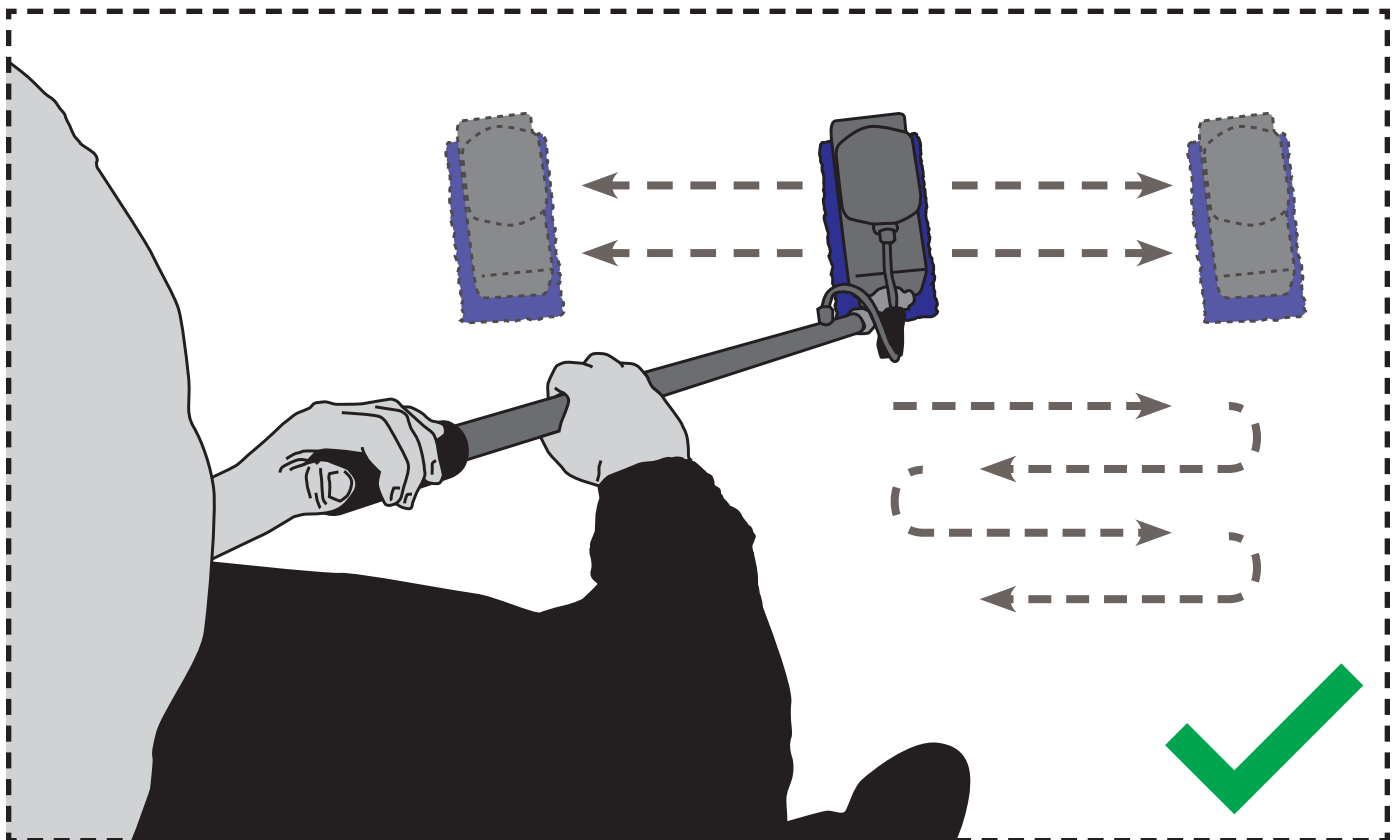
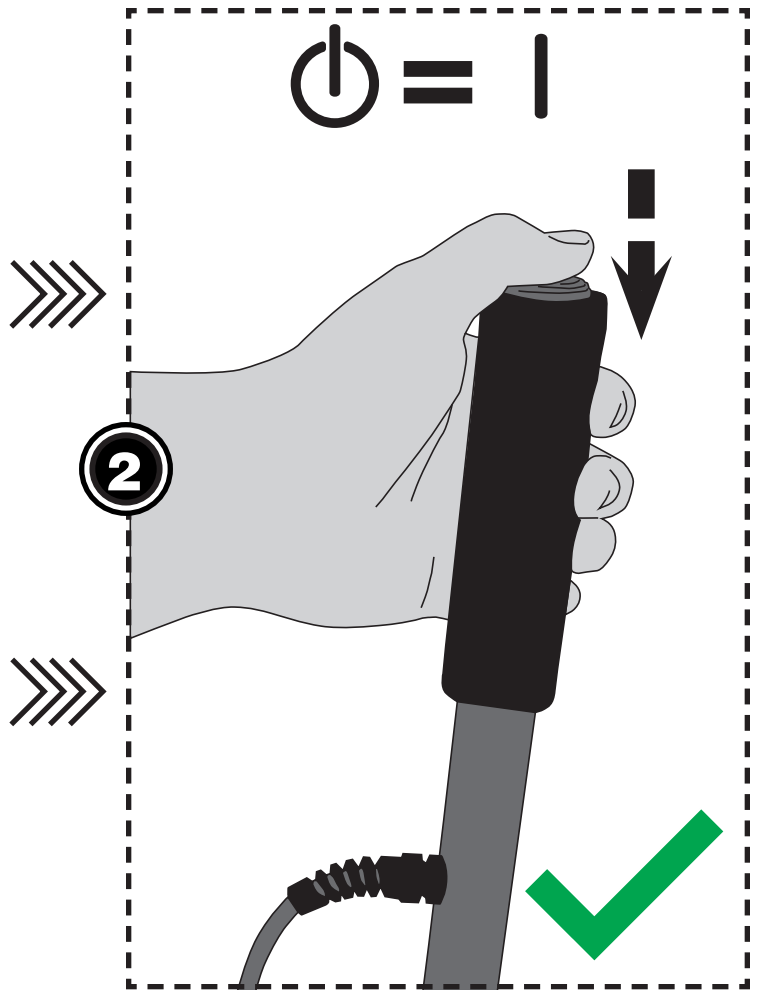
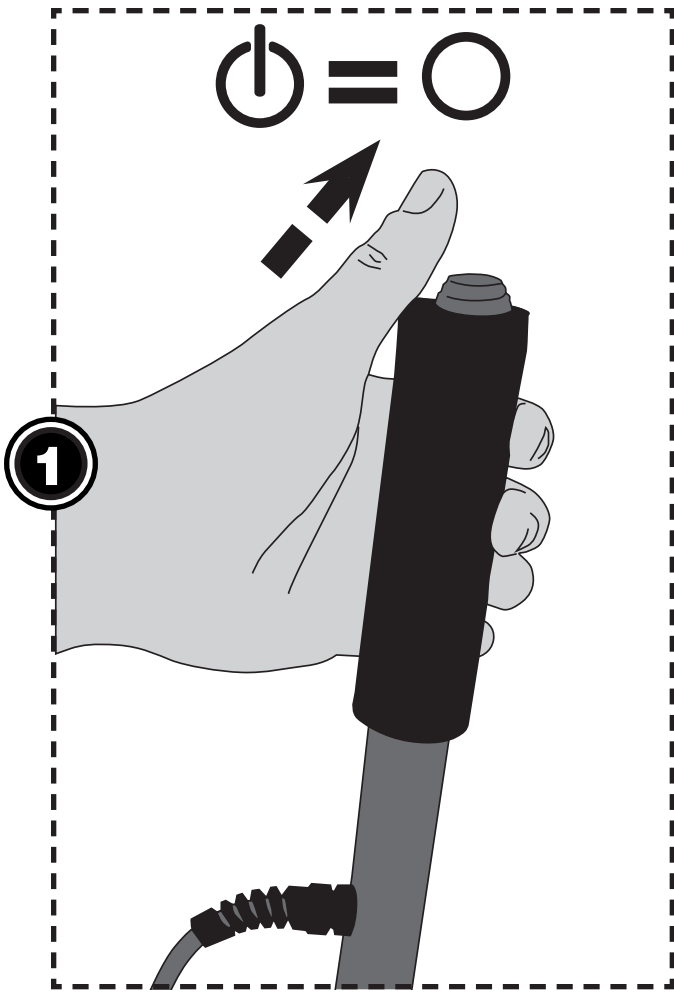

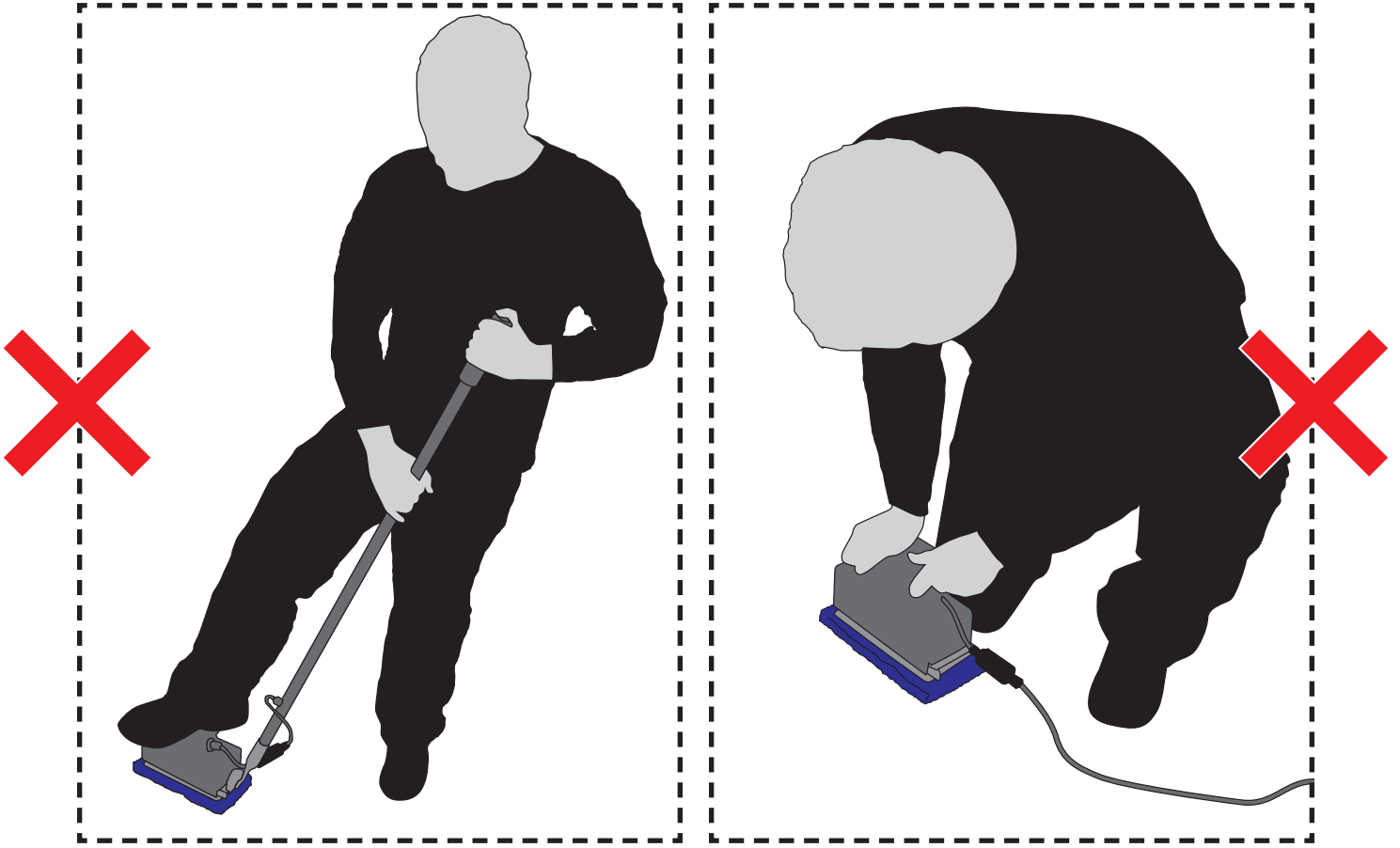

HANDLE ATTACHMENT

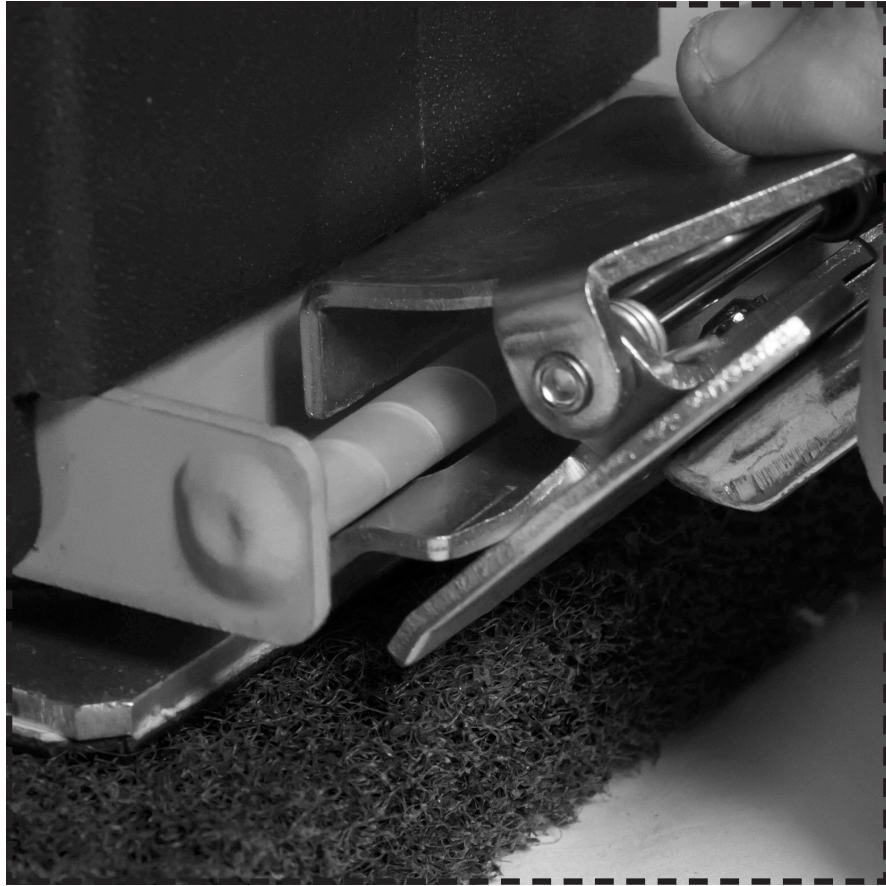

COMMON WEAR PARTS

NANO EDGE PADS:

PART NUMBER	DESCRIPTION
EDGE-7001	Black Strip Pad (20/cs)
EDGE-7003	Blue Scrub Pad (18/cs)
EDGE-7005	White Polish Pad (16/cs)
EDGE-7006	HD Dominator Strip Pad (20/cs)
EDGE-7007	ECO EPP Prep Pad (60/cs)
EDGE-7028	Tile/Grout Pad (1ea)
EDGE-7025	White Driver Pad (48/cs)
EDGE-7027	White Magic Eraser Pad (20/cs)

SPARE PARTS & KITS:

PART NUMBER	DESCRIPTION
900-1035	9" Plastic Grip Face

PARTS

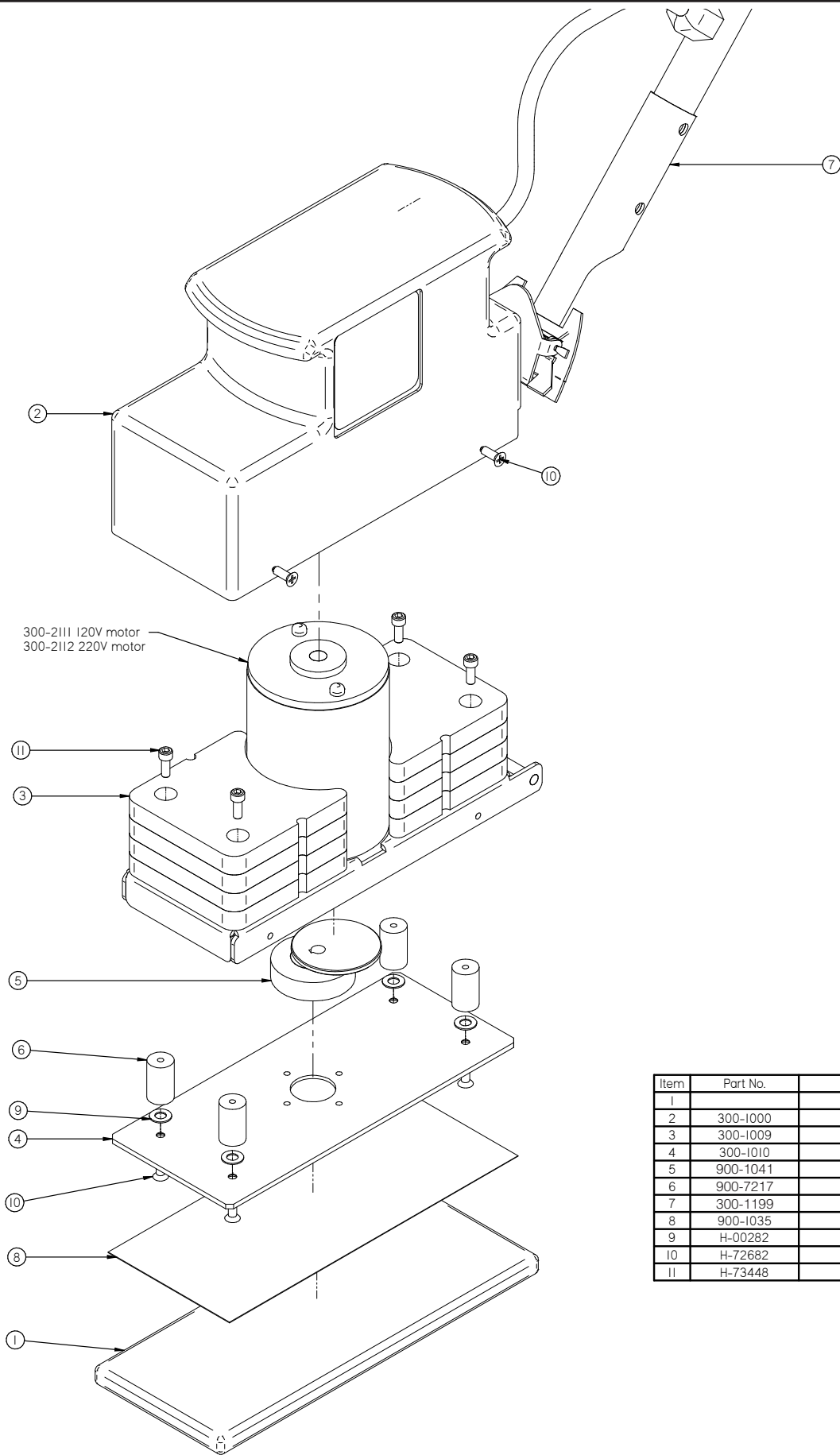

Item	Part No.	Part Description	Qty.
1		10 INCH Padpar	1
2	300-1000	COVER	1
3	300-1009	mini scrub base weldmnt	1
4	300-1010	mini scrub alumn driver plate	1
5	900-1041	ECCENTRIC BEARING ASSEMBLY	1
6	900-7217	mini scrub isolator	4
7	300-1199	handle	1
8	900-1035	GRIP FACE	1
9	H-00282	FW 1/4" NYLON	4
10	H-72682	FHP #10-32 X 1/2" SS	5
11	H-73448	SHCS #10-32 X 1/2" S/S	4

BLANK
THIS PAGE WAS INTENTIONALLY LEFT BLANK

TOMCAT[®]

Handmade in U.S.A. - 1986

www.tomcatequip.com 1711 South Street
Racine, WI 53404 (USA)

(800) 450-9824 | (+001) 262-681-6470